



# STTH6003TV/CW

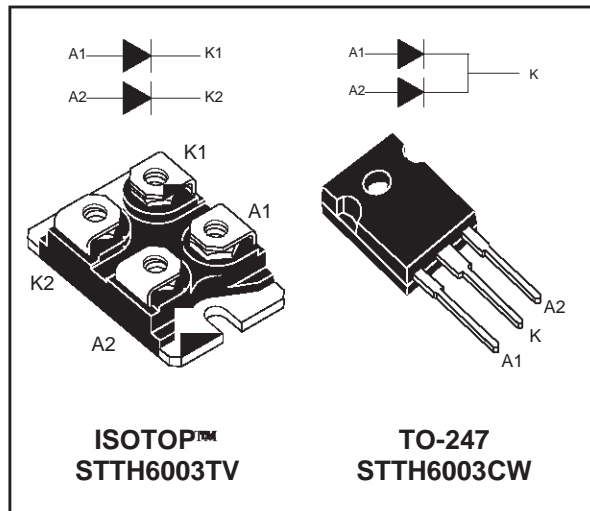
## HIGH FREQUENCY SECONDARY RECTIFIER

### MAJOR PRODUCT CHARACTERISTICS

$I_{F(AV)}$	2 x 30 A
$V_{RRM}$	300 V
$V_F(max)$	1 V
$t_{rr}(max)$	55 ns

### FEATURES AND BENEFITS

- COMBINES HIGHEST RECOVERY AND VOLTAGE PERFORMANCE
- ULTRA-FAST, SOFT AND NOISE-FREE RECOVERY
- INSULATED PACKAGE: ISOTOP  
Insulation voltage: 2500 V<sub>RMS</sub>  
Capacitance: < 45 pF
- LOW INDUCTANCE AND LOW CAPACITANCE ALLOW SIMPLIFIED LAYOUT



### DESCRIPTION

Dual rectifiers suited for Switch Mode Power Supply and high frequency DC to DC converters.

Packaged either in ISOTOP or in TO-247, this device is intended for use in low voltage, high

frequency inverters, free wheeling operation, welding equipments and telecom power supplies.

### ABSOLUTE RATINGS (limiting values, per diode)

Symbol	Parameter			Value	Unit	
$V_{RRM}$	Repetitive peak reverse voltage			300	V	
$I_{F(RMS)}$	RMS forward current		ISOTOP	100	A	
$I_{F(RMS)}$	RMS forward current		TO-247	60	A	
$I_{F(AV)}$	Average forward current	ISOTOP	$T_c = 95^\circ\text{C}$ $\delta = 0.5$	Per diode Per device	30 60	A
		TO-247	$T_c = 135^\circ\text{C}$ $\delta = 0.5$	Per diode Per device	30 60	A
$I_{FSM}$	Surge non repetitive forward current.	ISOTOP	$t_p = 10$ ms sinusoidal		400	A
		TO-247	$t_p = 10$ ms sinusoidal		300	A
$I_{RSM}$	Non repetitive peak reverse current		$t_p = 100$ $\mu\text{s}$ square		4	A
$T_{stg}$	Storage temperature range	ISOTOP			- 55 to + 150	$^\circ\text{C}$
		TO-247			- 65 to + 175	$^\circ\text{C}$
$T_j$	Maximum operating junction temperature	ISOTOP			150	$^\circ\text{C}$
		TO-247			175	$^\circ\text{C}$

www.DataSheet4U.com

## STTH6003TV/CW

### THERMAL RESISTANCES

Symbol	Parameter			Value	Unit
R <sub>th(j-c)</sub>	Junction to case	ISOTOP	Per diode Total	1.4 0.75	°C/W
		TO-247	Per diode Total	1 0.55	
R <sub>th(c)</sub>			Coupling	0.1	

When the diodes 1 and 2 are used simultaneously:

$$\Delta T_j (\text{diode 1}) = P (\text{diode 1}) \times R_{th(j-c)} (\text{per diode}) + P (\text{diode 2}) \times R_{th(c)}$$

### STATIC ELECTRICAL CHARACTERISTICS (per diode)

Symbol	Parameter	Tests conditions		Min.	Typ.	Max.	Unit
I <sub>R</sub> *	Reverse leakage current	V <sub>R</sub> = 300 V	T <sub>j</sub> = 25°C			60	μA
			T <sub>j</sub> = 125°C		60	600	
V <sub>F</sub> **	Forward voltage drop	I <sub>F</sub> = 30 A	T <sub>j</sub> = 25°C			1.25	V
			T <sub>j</sub> = 125°C		0.85	1	

Pulse test : \* t<sub>p</sub> = 5 ms, δ < 2 %

\*\* t<sub>p</sub> = 380 μs, δ < 2%

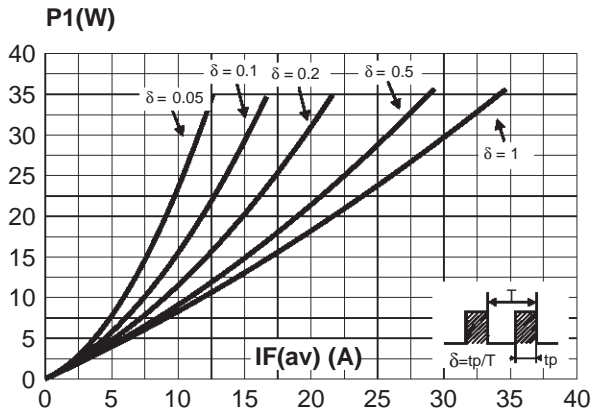
To evaluate the maximum conduction losses use the following equation:

$$P = 0.75 \times I_{F(AV)} + 0.008 \times I_{F(RMS)}^2$$

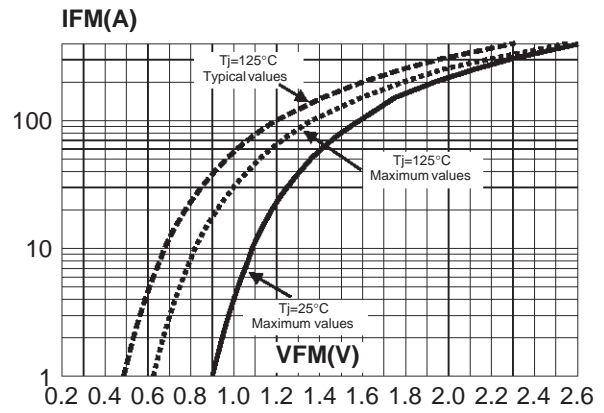
### RECOVERY CHARACTERISTICS

Symbol	Tests conditions			Min.	Typ.	Max.	Unit
trr	I <sub>F</sub> = 0.5 A	I <sub>rr</sub> = 0.25 A	I <sub>R</sub> = 1 A	T <sub>j</sub> = 25°C		40	ns
	I <sub>F</sub> = 1 A	dI <sub>F</sub> /dt = - 50 A/μs	V <sub>R</sub> = 30 V			55	
tfr	I <sub>F</sub> = 30 A	dI <sub>F</sub> /dt = 200 A/μs		T <sub>j</sub> = 25°C		350	ns
V <sub>FP</sub>	V <sub>FR</sub> = 1.1 x V <sub>F</sub> max.					5	V
S <sub>factor</sub>	V <sub>CC</sub> = 200 V	I <sub>F</sub> = 30 A		T <sub>j</sub> = 125°C		0.3	-
I <sub>RM</sub>	dI <sub>F</sub> /dt = 200 A/μs						11

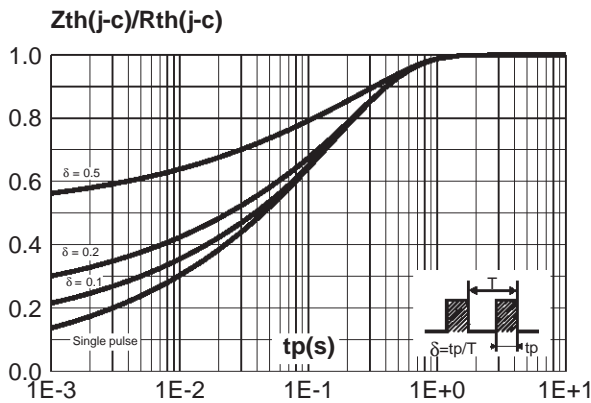
**Fig. 1:** Conduction losses versus average current (per diode).



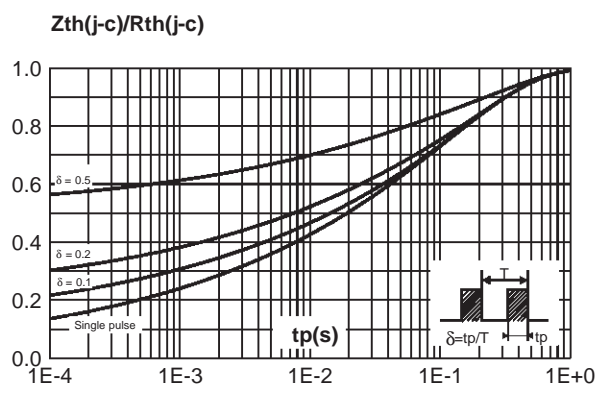
**Fig. 2:** Forward voltage drop versus forward current (maximum values, per diode).



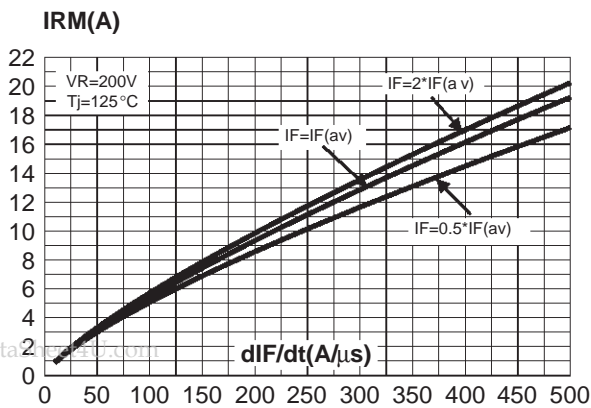
**Fig. 3a:** Relative variation of thermal impedance junction to case versus pulse duration (ISOTOP).



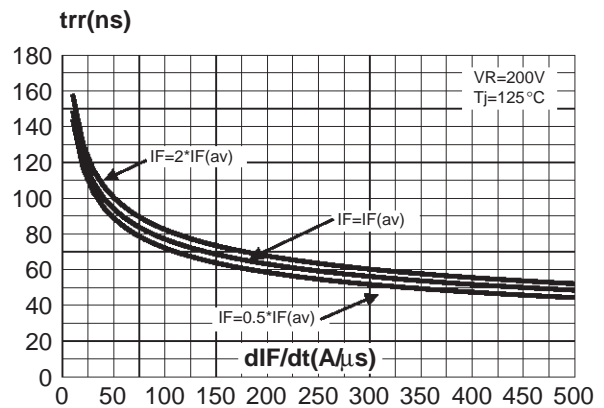
**Fig. 3b:** Relative variation of thermal impedance junction to case versus pulse duration (TO-247).



**Fig. 4:** Peak reverse recovery current versus di/dt (90% confidence, per diode).

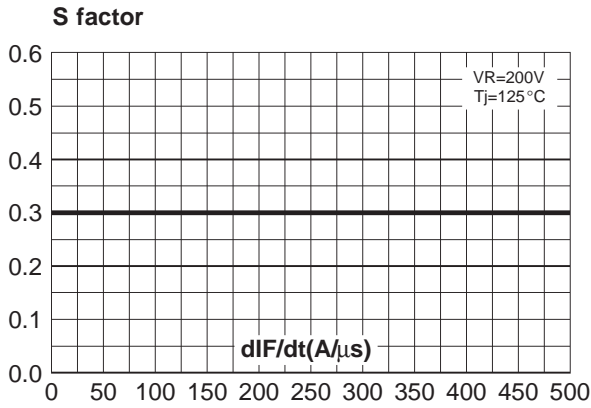


**Fig. 5:** Reverse recovery time versus di/dt (90% confidence, per diode).

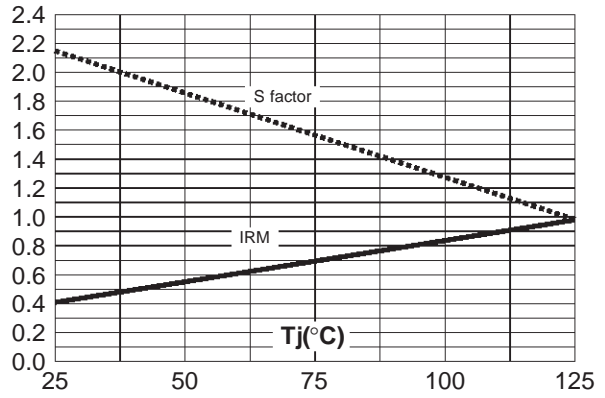


**STTH6003TV/CW**

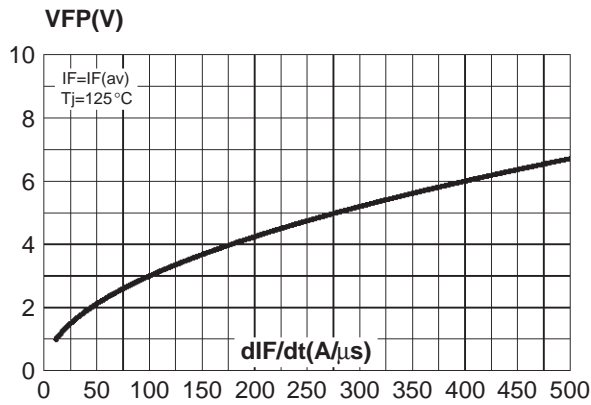
**Fig. 6:** Softness factor ( $t_b/t_a$ ) versus  $dI_F/dt$  (typical values, per diode).



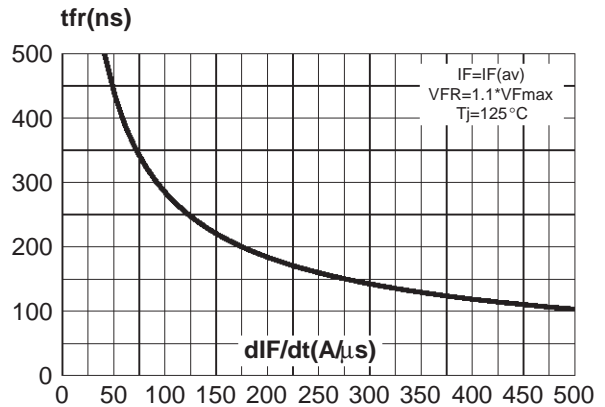
**Fig. 7:** Relative variation of dynamic parameters versus junction temperature (reference:  $T_j = 125^\circ\text{C}$ ).



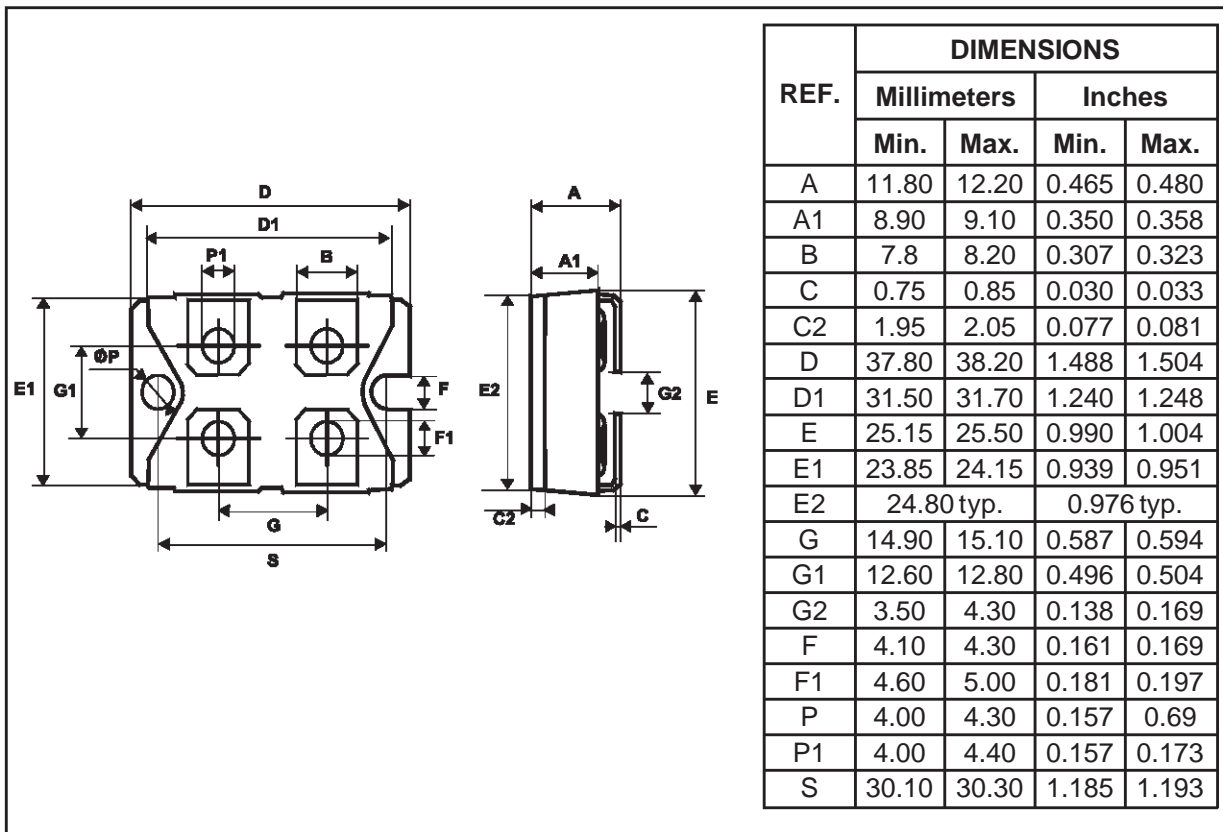
**Fig. 8:** Transient peak forward voltage versus  $dI_F/dt$  (90% confidence, per diode).



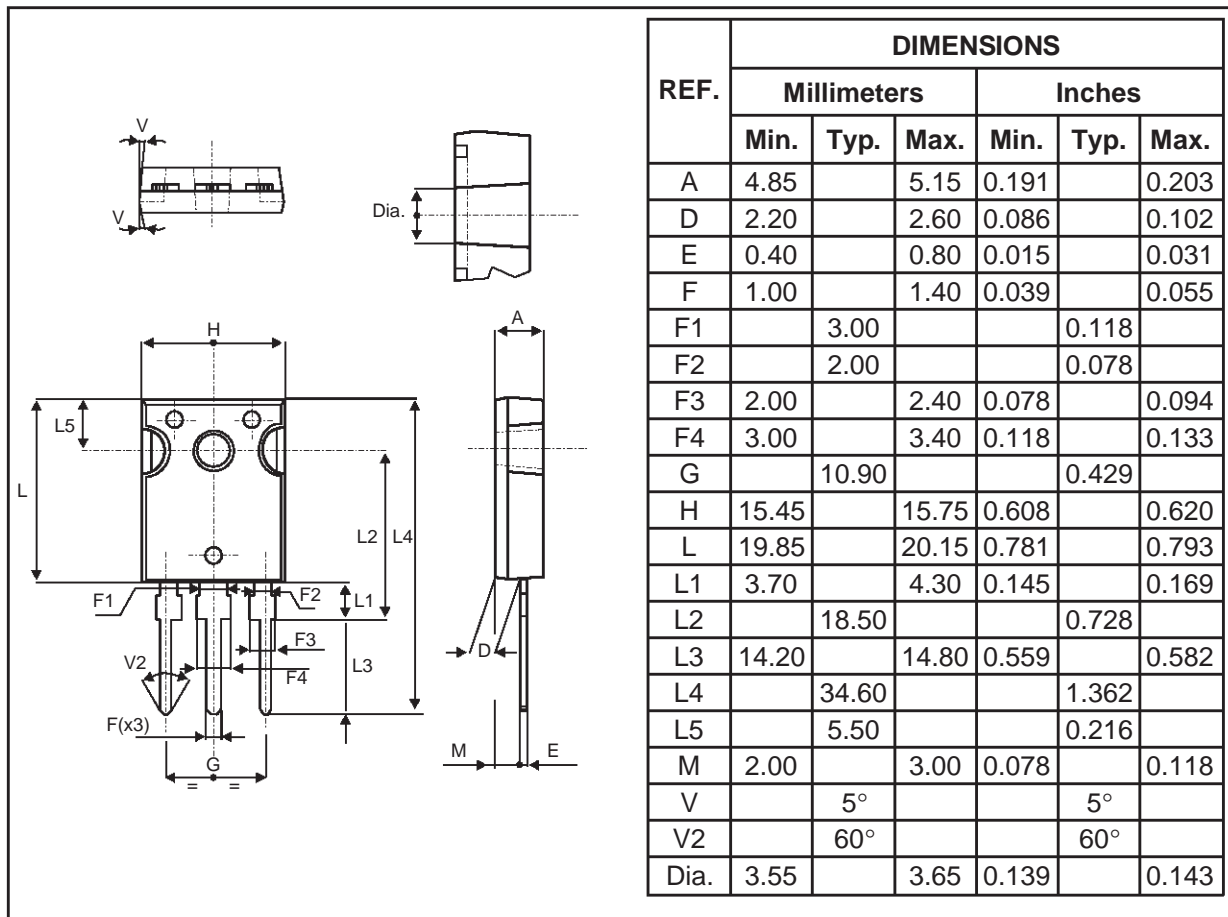
**Fig. 9:** Forward recovery time versus  $dI_F/dt$  (90% confidence, per diode).



**PACKAGE MECHANICAL DATA**  
ISOTOP



**PACKAGE MECHANICAL DATA**  
TO-247



Ordering code	Marking	Package	Weight	Base qty	Delivery mode
STTH6006TV1	STTH6006TV	ISOTOP	27g without screws	10 with screws	Tube
STTH6006CW	STTH6006CW	TO-247	4.36g	30	Tube

- Cooling method: by conduction (C)
- Recommended torque value (ISOTOP): 1.3 N.m.
- Recommended torque value (TO-247°): 0.8 N.m.
- Maximum torque value (ISOTOP): 1.5 N.m.
- Maximum torque value (TO-247): 1.0 N.m.
- Epoxy meets UL 94, V0

Information furnished is believed to be accurate and reliable. However, STMicroelectronics assumes no responsibility for the consequences of use of such information nor for any infringement of patents or other rights of third parties which may result from its use. No license is granted by implication or otherwise under any patent or patent rights of STMicroelectronics. Specifications mentioned in this publication are subject to change without notice. This publication supersedes and replaces all information previously supplied. STMicroelectronics products are not authorized for use as critical components in life support devices or systems without express written approval of STMicroelectronics.

The ST logo is a registered trademark of STMicroelectronics

© 1999 STMicroelectronics - Printed in Italy - All rights reserved.